

THE Chef's MAGAZINE

20
23

#1 EAT HEALTHY

#2 EAT RESPONSIBLY

#3 EAT EMOTIONS

#4 EAT FUTURE



la maison de l'Excellence®

 **SAVENCIA**
FROMAGE & DAIRY

Editorial

What are the consumer trends that will inspire you and enable you to invent the Cooking and pastry-making styles of tomorrow?

We propose to explore four mega-trends currently impacting pastry-makers, bakeries, restaurants and fine dining businesses internationally by giving you close-up views of concepts, ingredients, flavors, techniques and recipes, as well as several Chefs' portraits, to add a human touch.

Growing demand for health and well-being, the climate crisis, the search for emotions, the expression of stronger uniqueness among younger generations and the digitalization of society (teleworking, takeout & delivery, social networks, etc.) will all shape the world of food in the future.

In 2023, the economic situation is forecast to become tighter. Consumers are therefore redefining their perceptions of what the market offers and reevaluating their behavior, by factoring in the quality of products as well as their own intrinsic values, whilst carefully measuring costs.

We understand that each part of the world has its own cultural specificities and that you will be key players who will set the future trends wherever you are.

We are at your side, to inspire and accompany you in taking up and meeting these challenges, to invent a better food world, while maintaining pleasure and perpetuating desire.

Enjoy!

contents

P 04	#1 Eat healthy
P 12	#2 Eat responsibly
P 20	#3 Eat emotions
P 28	#4 Eat future
P 36	Savencia Cheese & Dairy
P 37	La Maison de l'Excellence



trend #1

eat healthy

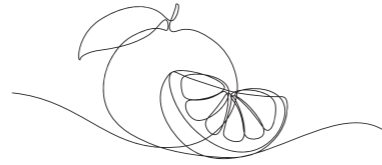

The link between food and health has now become obvious for consumers. Covid accelerated this trend, but consumers simply no longer want to compromise on taste. They are looking for a more balanced offer that allows them to eat healthily in a pleasing way.

well-being
freshness
nutrition
naturalness
guilt-free



67% of European consumers prefer a simple and clear menu, reassuring them that products are fresh, natural and seasonal. (NPD 2022)

60% of consumers worldwide agree that fruit and vegetable flavors are generally good for their health. (Innova Flavor Survey 2022)

2/5 Consumers worldwide are increasingly looking for F&B that make them feel comforted and relaxed (Innova Flavor trend 2022)

71% In Asia, of consumers intend to increase their spending on health and wellbeing products. (Innova Market Insights 2021)

micro-trends



1

Make the ingredient sublime

Simple, not too sweet, not too fat, but bursting with flavor. We focus on the main ingredients that provide an explosion of flavors. We reinforce their nutritional value by adding ingredients that are clearly recognized as healthy, as we make full use of the benefits of Mother Nature.



2

Ultra fresh & seasonal, self-produced

As an artisanal producer, we make food ourselves, we produce inhouse for more freshness, taste and benefits, our offer comes directly from the farm or, as we say, from the field to the fork.



3

New drinks, low in alcohol or alcohol-free, bursting with flavor

Alcohol is no longer trendy for Millennials and Generation Z. They want to have fun without feeling like they're damaging their health. They want to enjoy themselves without harming themselves - kombucha, kefir, mocktails and alcohol-free versions of the classics are popping up everywhere.



4

Functional food

With enhanced nutritional benefits (e.g., rich in proteins for active people, rich in antioxidants, promoting immunity, etc.), in line with the keto diet trend in the US and the cosmetic food diet trend in Japan.



The Chef's interview

Josh Boutwood

- Executive Chef of Bistro Group (120 outlets in the Philippines).
- Chef and owner of The Test Kitchen, Savage, Helm & Ember (very chef-centric and therefore a daily challenge)
- Elle & Vire Professional Ambassador

@chefjoshboutwood

«All my restaurants include dishes that are healthy as part of the standard menu.»

«Aside from their probiotic properties, fermented foods have more depth of flavor.»

Have you witnessed the shift in the Philippine market towards healthier food alternatives?

Social media has played a big part in the healthier lifestyle trend. I don't feel it's as obvious yet in the Philippines. But like most trends, we see them emerging in larger cities before they make their way to us. **All my restaurants include dishes that are healthy as part of the standard menu**, yet I don't feel the urge right now to invest in a new concept exclusively centered on that.

How do you source your ingredients?

We have carefully chosen suppliers and farmers who understand our needs and are able to fulfil our demand. **A lot of what we do is very 'field to fork'. Working with small producers who love what they do** alters the flavor, and you can really taste the difference. Also, having the knowledge and understanding of where a particular product comes from is a bonus and being able to share that with our diners makes them feel more connected and involved with the experience.

How much of your menus are comprised of vegetable-based dishes?

The Philippines is well known for overcooking vegetables and thus limiting the amount of

nutrients you benefit from when you consume them. We have made it a point that **each dish includes 20% of vegetables, cooked properly to preserve as much of their nutritional value as possible.**

Did you see a shift in ordering patterns for plant-based dishes since the pandemic?

Not as much as the rest of the world. We saw a higher increase in Vegan demand after the release of a Netflix Documentary "The Game Changers". We have a meat and seafood culture. I also strongly believe when guests dine in our restaurants that they are looking for an experience.

Which ingredients do you often use to boost the healthiness of a dish naturally?

Soursop is such an underrated fruit and I believe its flavor is adaptable to multiple cooking techniques, from fresh or vinegary, by adding a twist to savory dishes. Fibers, fresh vegetables and citrus also bring brighter flavors to dishes. Aside from fermentation, raw food was a trend a few years ago and I still believe it's the most nutritional way of eating.

You mention fermentation, what's your thought on this?

Fermentation is very important to me. **Aside**

from its probiotic properties, fermented foods have more depth in flavor. Since day one, we have focused on using preserved ingredients in each dish as a way of increasing the umami and intrigue of the dishes.

In the Philippines, healthy eating can sometimes mean expensive eating? How can you counter this idea?

It's important to understand the true meaning of healthy. With the right information and knowledge on what is and is not healthy, you can appreciate that the price difference is not the main factor.

What is your vision for the future?

My vision has always been centered on sustainability, while providing guests with an opportunity to create memories when they dine with us. Limiting the amount of waste and creating value-added dishes to menus that use what could be perceived as something we would normally discard is really important. Giving an ingredient longer shelf life has helped us preserve ingredients for later use. Waste has been a major factor for years in our industry and limiting those numbers is a priority we got involved in over six years ago, and it is still work-in-progress.



“Teatime”

by Felicia Huang

Pastry Chef at Sinodis, China

Matcha is well known for its benefits.

With its wealth of vitamins, amino acids and antioxidants, this green tea powder is definitely a superfood.

According to the Pastry Chef, combining her dessert with Excellence Elle & Vire cream adds richness to its flavor.



scan for the recipe

Ingredients & flavors

24% of consumers worldwide choose “fresh and spicy” tastes when they want to feel healthy, while 19% pick sourness.

(Innova Flavour 2022)



HEALTHY FLAVOURS: spices, citrus fruits, aromatic plants, mushrooms, seaweed.

Focus on citrus fruits: There are a multitude of citrus fruits in diverse regions of the world during different seasons. Japan has a wide range of citrus fruit: yuzu, hassaku, kabosu, sudachi, citrons, grapefruits (often of Chinese origin), mandarins, clementines, combava lemons (from Indonesia), caviar lemons, kumquats, kalamansi (from the Philippines), Pompia (originally from Sardinia). The list is endless!

22% of consumers have reduced their consumption of sugar

(NDP 2022)



NATURAL SWEETENERS: fruit, especially figs and dates, cinnamon, coconut flower sugar, honey, vanilla, sweet potato syrup, tapioca syrup, yacon syrup, etc.

Focus on chicory syrup. Chicory is a plant that grows naturally in Europe, India, and North Africa. Its roots are what are mainly used in cooking and baking. It improves gastrointestinal comfort and provides antioxidant and anti-inflammatory benefits. A chicory root contains 15 to 20% inulin (chicory root fiber), which can be used as a sugar substitute in pastries, jellies, jams, etc.

14% the share of edible CBD in the CBD market mainly in confectioneries, chocolates, or drinks (IRI/BDSA 2021)

CBD OR CANNABIDIOL is a natural cannabinoid found in the cannabis plant (hemp).

It has no psychoactive effects. For culinary use, CBD is available in a variety of forms, ranging from dried hemp flowers, leaves or oils and in ready-to-use products, such as flavored oils and vinegars. However, its legal status varies from region to region.

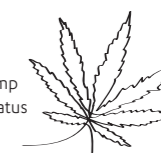

the technique

FERMENTATION AND 'LIVING' FOOD

+21% of fermented food launches worldwide (CAGR 2017 - 2021) (Foodingredients)

The process of fermentation is useful both in boosting a product's shelf life and its nutritional value. It also contributes to the detoxification of wild or domesticated plants (such as cassava, cereals and legumes - soybeans, cowpeas, miso). Fermentation makes food more digestible. It preserves most vitamins, minerals and trace elements and facilitates their proper assimilation. It is known to improve immunity by boosting the microbiota to create a more lively and active flora.

the vision

la maison de l'Excellence®



The search for **natural, healthy and full-flavored savory foods** and pastries is a compelling and growing desire. We try to use simple and natural additive-free ingredients and healthy cooking methods. We rework the recipes to increase their balance. Beyond the **sourcing of proper ingredients**, we are also committed to working in a way that generates **the best result, seeking to find the right balance of ingredients** as we always have in traditional cooking, a little like the yin and yang of Asian culture.



“ Eat vegetables again in a gourmet way, by **varying pleasures**, such as using grilled vegetables rather than fried chips or putting carrots in cakes. ”

inspiring places

California
SINGLE THREAD
- Co-managed by a chef and a farmer
- A unique style of Japanese cuisine with ingredients grown on smallholdings
- Manually-worked lands and hand-picked produce, in harmony with the seasons



singlethreadfarms.com

London
BUBALA
- A new generation of vegetarian restaurants, known for their 'beyond vegan' cuisine
- No meat substitutes, no synthetic or processed products
- Using all available vegetables and drawing what they offer that's most sublime, through fermentation



bubala.co.uk

Thailand
IBERRY
- High quality artisanal ice cream and berries,
- Fresh ingredients and natural tastes with no artificial colors or flavors
- 100% natural-tasting Thai tropical fruits
- Naturally rich in vitamins and antioxidants: santol, pandanus, taro, tamarind, and durian.



iberryhomemade.com

Paris
wildandthemoon.fr
WILD AND THE MOON
- Uncompromising taste lovers!
- 100% organic, 100% plant-based, 100% homemade
- No additives, no plastic, no food waste, and as local as possible
- Traditional food preparation know-how to increase the nutritional strength of food (soaking nuts, pre-sprouting, etc.).



Inspirations



food for thought...

FOOD THERAPY?

Will we go to a restaurant one day instead of going to see a doctor?
Will we take out a subscription to a restaurant to have a 'gourmet goodness' cure like we register in a fitness center? In France, the home delivery brand "Comme j'aime" currently offers programs for weight loss. Can we potentially conceive and design curative programs to provide functional benefits, such as enhancing beauty, reducing cholesterol levels, etc.?



eat responsibly



Consumers around the world are increasingly aware of the impact of global warming and climate change. This means they now expect brands and food industry players to contribute to a societal effort to help them become better consumers.

transparency *local* commitment
 balance
 positive impact *planet*



micro-trends



1

local eco-system

People are rediscovering local ingredients and know-how; sourcing is being redeveloped in short circuit systems with the establishment of strong bonds between partners who are passionate about their products and professions.



2

Zero Waste!

Reducing waste overall and reducing food waste in particular. Getting back to the basics of cooking with the use of all parts of all ingredients, true for plants, as well as for animals and fish.

3



the "Classic Veggie"

Transforming a classical recipe into a vegetarian dish (e.g., chili sin carne, vegan fish and chips, etc.). New **alternative protein** ingredients are being developed using lentils, peas, beans, seaweed, mushrooms, jackfruit, as well as a means to replace seafood products.

4



Sourcing ingredients with a positive impact on the planet,

using **regenerative farming methods**, which revitalize the soil and promote biodiversity. Having originated in the US, this micro-trend is now being developed in Austria, Switzerland and Germany.

61%

of European consumers choose a restaurant with local produce. (NPD 2022)

10 to 15 million tons

of food waste are generated by US restaurants each year. (Foodprint)

90%

nearly of the world's marine fish stocks are fully exploited, overused or under severe threat from overfishing, according to the United Nations.



29%

of European consumers prefer restaurants with a vegetarian/vegan option. (NPD 2022)

The Chef's interview



«...we're a profession strongly rooted in the land, these are our values.»

Benoit Castel

Pastry Chef and baker

- 3 shops in Paris "10 minutes by bike from each other"
- Last opening (2022): FOOD delicatessen with homemade and ready-to-finish-at-home products
- Lescure Ambassador



Benoît, could you introduce yourself in a few words?

My name is Benoît Castel, **I'm a pastry Chef and baker.** I'm in fact more of a pastry Chef than a baker. My career has been more in pastry making but, for the last ten years, I have been playing the 'bread game', which I really enjoy. I also work a lot in the restaurant business on weekends, especially in Ménilmontant, where we offer a homemade-style brunch.

What do you like about the world of baking and pastry-making?

What I really like about the world of bakeries and pastry shops is that, above all, they are real places to enjoy life today. **We are very close to the people we serve. A bakery is an essential part of daily life.**

What do you think is most important in your strong commitments as a Chef?

We have an important role, I always say, in **the choice of our raw materials.** As a Chef and as an artisan with a business, people come to us to buy things that they put in their mouths.

So, for me it's essential that the raw materials we use are of good quality.

How do you define good quality sourcing?

Sourcing means taking pleasure in meeting the person who grows the vegetables, who brings them to us directly. We enjoy that.

And then we say it, people know that we're going to work with organic flours, we're going to work directly with millers. That's why people come to us every day, because they know how we work in harmony with others.

You've even started a vegetable garden, haven't you?

For almost a year now, we have been preparing a vegetable garden in Brittany (I have my roots there). We would like to make some of the vegetables for our own shops, for our brunches and for the grocery store. We will certainly make our tomato sauces because it's true that the garden really comes to life in July and August. We have less work in Paris during that time of the year, and it's also good for our state of mind garden and do

something different. We asked ourselves, "What kind of tomatoes should we plant, what kind of varieties do we use?" It's great. **It's good for the teams, too. We're a profession strongly rooted in the land, these are our values.**

Have you taken any other initiatives?

There's our whole anti-waste approach, which is now becoming trendy, but which we started applying a long time ago in the pastry business. For example, to make toppings, we use all our apple cores and skins.

If more people started respecting raw materials more, which involves throwing away a lot less, we would save a time on many things. When we use carrots, we brush them, we don't peel them. If the carrot has been properly grown, it has no pesticides. You can eat the skin, so you don't have to peel it, which is very good.

Could you tell us about your "bread of yesterday and tomorrow"?

For two years, we have been producing a bread called "Yesterday and Tomorrow Bread", which is a real virtue.

We recover all our unsold bread, and we make a new bread from the leftovers. We have a special process, which I discovered with a friend, Pierre, in Austria, who had developed this technique. It took us about a year with my team to get it going here. And today, it's generating unbelievable sales!

The problem, of course, is that it often costs more to make good products.

We are careful to offer our products at a fair price. Despite costs exploding today, we really do try to stay within a fair price range, while producing a quality product. Afterwards, we make breads that are more expensive than the average, which is true for pastries too. But we have a real point where **we want to make sure our products remain accessible. We are an integral part of the neighborhood,** because people come to our shop every day.

We have a very simple-looking pastry shop, without any fancy decoration. We use our little shortbread, which is my brand signature, and we want to maintain an unpretentious style.

"Leek in 7 ways"

by Bastien de Changy

Nomadic Chef - Gault & Millau 2021 Young Talent Award

The entire leek is worked in association with Reine-des-près and Elle & Vire Excellence cream. The whites are candied or oven-baked, the greens are made into jams, oil or powder, the rootlets are fried or dehydrated: seven ways to give this timeless vegetable a newfound nobility.



scan for the recipe

Ingredients & flavors



61% of European consumers choose a restaurant with local produce (NPD 2022).

THE FLAVORS OF THE LOCAL MICRO-CUISINE: salted egg yolk, strawberries, Asian chestnuts, salted butter caramel, chaat masala...

Focus: Yaupon is a variety of holly native to the southeastern United States, the only known indigenous caffeinated plant in North America. Native Americans brewed it into a tea or "black drink" for purification rituals. Fresh yaupon leaves produce a tea that tastes like green tea, while dried or roasted leaves taste more like yerba mate. Yaupon contains theobromine, like dark chocolate, and is said to have an energizing and stimulating effect.

+27% in launches of food and beverages that claim to reduce water usage (% CAGR 2017-2021 – Innova Market Insights 2022)

"This beer saves water" is made with Sinagua barley malt. It is produced in the Verde Valley by local farmers in late winter/spring to use less water during periods of high demand (late spring/summer). This is a way of responding to the declining flow of the Verde River.



1 leguminous plant from each country of the participating teams honored during the Bocuse d'Or 2023

Leguminous plants are at the heart of everyday cooking in Asia and provide an indispensable source of protein. Their diversity, nutritional wealth, contribution to soil health (nitrogen fixation) and biodiversity make them allies of more sustainable food systems in all parts of the world. Latin American chocho (or tarwi beans) grown in the Andes and used for everything from soups and main courses to drinks and desserts, broad beans, native to the Mediterranean and Central Asia, Bambara peas from West Africa, adzukis widely used in Japan, Korea, and China, etc.

the technique

THE EMPTY TRASH CAN GAME

4 to 10% of restaurant supplies in the US are wasted before they reach the consumer (Foodprint)

Set up a group game and create a meal that results in an empty trash can, to encourage the teams to reuse and transform everything they have, to rethink their recipes and portions, to limit waste, or even to offer a "trash" dish on the menu.

the vision

la maison de l'Excellence



For many years now, Chefs who feel close to their product and their region, have become pioneers, sounding the alarm about the decrease of natural resources and biodiversity.

Beyond local sourcing, it's important for all of us to reduce our footprint on the planet, to manage our supplies more carefully and to modify our methods to not waste resources.

It's a **return to the basics of artisanal cooking**. Our aim is to offer gourmet products that benefit everyone and are processed in the best way. In short, **no compromises on what's better for me and better for us all.**



“ **Full respect** for products and by-products. Rework all by-products before throwing them away (peels, carcasses, bones etc.). Rediscover the joys of a **short menu** that is **flexible** and adapted to local daily deliveries... ”

inspiring places

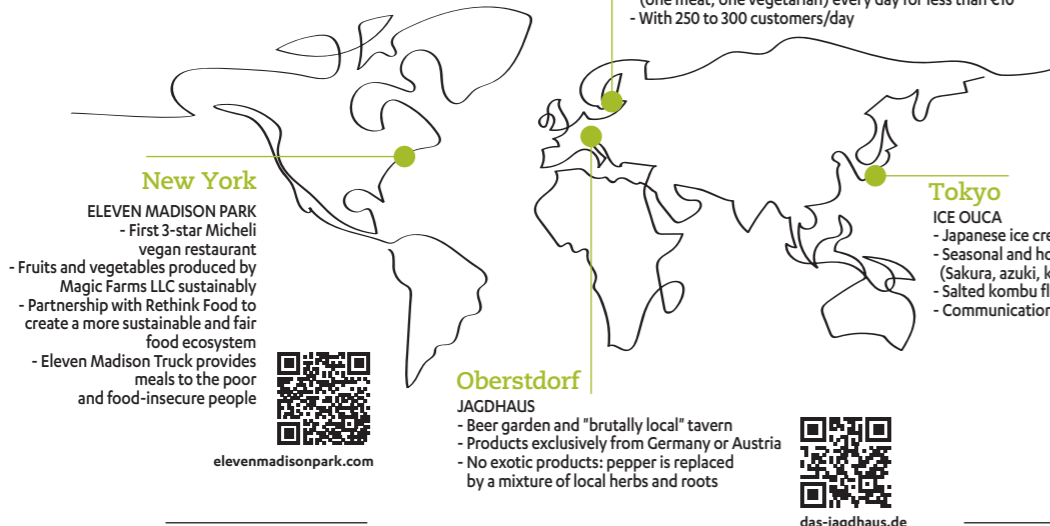

New York

- ELEVEN MADISON PARK
- First 3-star Micheli vegan restaurant
- Fruits and vegetables produced by Magic Farms LLC sustainably
- Partnership with Rethink Food to create a more sustainable and fair food ecosystem
- Eleven Madison Truck provides meals to the poor and food-insecure people



elevenmadisonpark.com

Malmö

- RESTAURANGSPILL
- Erik Andersson Mohlin (Chef) and Ellinor Lindblom Mohlin (restaurant manager)
- A simple mission: fight food waste
- Using unsold food from suppliers, preparing two dishes (one meat, one vegetarian) every day for less than €10
- With 250 to 300 customers/day



restaurangspill.se

Tokyo

- ICE OUCA
- Japanese ice cream cafe
- Seasonal and homemade flavors (Sakura, azuki, karinto, kokuto...)
- Salted kombu flakes to cleanse the palate after ice cream
- Communication in the form of Japanese poetry



ice-ouca.com

Oberstdorf

- JAGDHAUS
- Beer garden and "brutally local" tavern
- Products exclusively from Germany or Austria
- No exotic products: pepper is replaced by a mixture of local herbs and roots



das-jagdhaus.de

Inspirations



food for thought...

A NEW EUROPEAN COFFEE SOON?

Global warming is profoundly changing farming and crops. In Sicily, high temperatures and lack of water have made citrus cultivation uncertain but enable the possibility of raising crops that were previously grown exclusively in equatorial zones! In addition to exotic fruits (mangoes, papayas, avocados), the Morettino family has started growing coffee. For the first time in 30 years, a crop of 30kg of coffee was roasted! **Good or bad news?**



eat emotions



exciting delightful
offbeat *sensorial*
uniqueness
exploration
surprise



Consumers are looking for ways to escape everyday routines, of finding pleasure and chilling out. People are always seeking to reconnect to their emotions, whether these remind them of their childhood, enable them to travel to other worlds or simply by having fun. Today, good food is an accessible small luxury, that allows them to do just that! Food is also becoming a new religion for Gen Z, allowing them to assert their uniqueness. The principle is that it's more important to find pleasure than to respect conventions.

micro-trends



1

Newstalgia

Responding to the consumer's double desire to revisit things that are familiar and reassuring while, at the same time, to discover what is new and exciting. A childhood product reinvented with a fresh and exotic flavor or with a slightly transgressive ingredient.



2

Little ultra-gourmet & accessible luxuries

Little gourmet pleasures, which we allow ourselves in a high-end, yet affordable, version give us the chance to reward ourselves or to relax, but in a healthy version of course (see trend #1)



3

Dreams of escaping and authentic exoticism

Rediscovering the original flavors of faraway lands that you've always dreamed of. European artisanal pastry continues to develop itself in Asia. Korean, Thai or Levantine cuisine continues to stimulate the imagination of Europeans and Americans.



4

Eatertainment and viral culinary creativity

Transforming what we eat into an immersive and playful experience by appealing to all the customer's senses, with extravagant and offbeat versions of products.

62%

of millennials look for customized experiences
(Euromonitor 2021)

More than 50% of consumers worldwide want to be more adventurous with their F&B choices
(Innova Trend 2021)



73%

of US consumers enjoy things that remind them of their past
(Mintel 2022 / Whole foods 2023)

30%

of consumers worldwide are looking for F&B flavors that are native, sourced from their own heritage
(Innova Flavor 2022)



The Chef's interview

«I'm always keen to understand more about the reason behind the method or approach.»

Chong Ko Wai

Co-founder of C3-Lab

Chef Ko Wai's successful career has been achieved in Taiwan and Malaysia

• Professor at the Malaysian Academy of Pastry Arts for eight years

• 2nd place at the Mondial des Arts Sucrés in Paris (2016)

• Elle & Vire Professional Ambassador

@Bread Pitt

How do you manage this consumer's double desire for familiarity and innovation, which could be called 'newstalgia'?

Today, I use the various preparation techniques that I learned abroad, which include traditional and modern methods, with local ingredients such as coconut sugar, red beans, calamansi, etc.

How can pastry continue to surprise and personalize experiences?

The growing "Omakase" trend opens doors for pastry Chefs to be more adventurous when innovating in their recipes and will encourage more possibilities in terms of taste and the way the pastry is served (à la minute style, for example). Hopefully, this trend will let more consumers appreciate and value the Chefs' efforts.

How serious should pastry be?

Pastry can be playful and serious at the same time:

- 1) Playful during research and development, never afraid to embrace failure as this is very important to achieve a satisfying and breakthrough result.
- 2) Serious when preparing the food to serve our guests, since consistency and precision are very crucial to ensure that quality is maintained.

As Bread Pitt, you also play with words on social media.

Instagramable has been one of the words widely used to talk about food over the years, but in my humble opinion, the taste of food should be as good as possible in the end since that's what we experience above all. So, it's very important for me to keep reminding myself to keep a balance between what's Instagramable, edible and practical so it can be produced simply at all times.

You've been called the "architect of the cake" by playing with combinations of flavors and appearance. Where are you heading now?

Light but well-defined flavors and tastes, lighter textures, leaning more towards food-related colors, a more monochromatic color style, rounded, organic and more neutral shapes without too much complication.

What do you think of the new approaches in pastry making?

It's a trend indeed where many people are constantly trying new approaches which might be labeled as 'Chaos cooking' from the perspective of the fundamental way of making pastry. The preferences and expectations of consumers have changed over the years and



certain technologies and equipment can totally change the traditional ways of pastry preparation. Personally, I'm not against this approach and sometimes even embrace new preparation methods, but I'm always keen to understand more about the reason behind the method or approach. It's very important for me to understand the purpose of any change.

What do you think classical pastry brings to the table?

I personally feel classical pastry is very historical, filled with strong charisma (Paris Brest, Opera, Tiramisu, Black Forest). There is always something for us to explore even if it's classical because this combination has traveled and maintained itself for long periods of time. It took me quite a few years to understand the actual taste of legendary classical pastries before I innovated and adapted them to suit my needs and preferences. Take Opera, for example, the height is around 2.5 to 3cm, as this will provide a very good balance of taste, not feeling too fatty or heavy to eat

because the butter cream and ganache are spread in thin layers.

What advantages do new technical solutions bring you?

On the downside, I personally do not appreciate classical lemon curd because of its egg flavor. But eggs were essential back then in classical lemon curd formulations because they kept the recipe emulsified and the eggprotein provided body to the final product, giving it a homogenous feel when eaten. In recent years, I have been able to remove eggs from lemon curd because I've had access to certain ingredients which enable us to replace the function of eggs in classical recipe formulations. The result is a cleaner taste of fruit without the distractions of eggs. Thanks to these new functional ingredients and equipment, it has given Chefs more freedom to innovate in their creations.

What should the patisserie of tomorrow be like?

Hopefully, pastry in the future will be innovative but also respect certain fundamental criteria, thus enabling us to preserve the heritage.

"Blackberry & blackcurrant Tourbillon" by Yann Brys

Pastry Chef MOF 2011
- Tourbillon Pastry Chef
Chef of the Evok Group
- Elle & Vire Professional Ambassador

Tourbillon was inspired by a wild berry picking outing in late August. In this recipe, blackberries and blackcurrants are spiced up with a hint of ginger and softened with a light vanilla cream and crunchy thyme shortbread. The swirling visual is an asset to reveal the rich and satisfying taste, according to Chef Yann Brys.



scan for the recipe

Ingredients & flavors

+138% increase in spicy flavors on bakery menus this year in the US (Mintel 2022)

"SWICY FOOD" is a contraction of "sweet and spicy"

Complex flavors and unexpected combinations - sweet and spicy (Chili varieties with sweet ingredients in pastries), such as sweet and umami (caramel/miso) or sweet and sour (honey/yuzu).



49 % of Americans are interested in street food from other countries (Dataessential 2022)

The flavors of street food (#Street food)

Beyond food trucks and street food festivals, the flavors of street food are making their way into menus. The taste of mangonada, Mexican grilled street corn (elote), chili crab, takoyaki, kebab and chaat masala, for example, create a surprise and a feeling of authenticity.



1,7 million #falafel posts on Instagram

Levantine cuisine, with its richly flavored spices, vegetarian recipes, use of fresh herbs and varied accessible dishes is designed to be shared in a convivial atmosphere (mezze, falafel, kofta, shakshuka, babaganoush, muhammara ...).

the technique

MULTI-SENSORY - NATURAL WOW EFFECT

3/5 consumers are interested in trying new sensory experiences (taste, texture, color, feel) Innova 2020.

Texture and color in toppings, inclusions or inserts, with hidden tastes to create more surprises. Natural ingredients: ube provides its purple color, beetroot or hibiscus flowers enliven decoctions with their strong red hues, or infused butterfly pea flowers bring a surprising blue color to a variety of drinks.

the vision

la maison de l'Excellence®



Keeping desire alive, generating emotions (often by recalling childhood memories) and creating pleasure are the hallmarks of our professions.

The Chef's generosity is essential because not everyone is ready or happy to stay back in the kitchen and simply occasionally observe people enjoying themselves in the dining room.

What's essential for us is to preserve the joy and desire of giving to others.



“ Offer an **"Omakase"** or limited editions to surprise and create desire. Omakase, a Japanese expression which means: "I leave it to you", is asking the chef to surprise his guests by giving him or her the freedom of making their own selection – it's the story of a relationship, a way of exchanging and expressing trust. ”

inspiring places

San Francisco
BUTTER&
- The traditional American buttercream cake with a focus on flavor
- Three Styles: floral, textural, or playful
- Strong ethical commitment in personnel management

butterand.com

London
SPEEDBOAT BAR
- Authentic Exotism: being in London's Chinatown, feeling as if you were in Bangkok
- A farm in Dorset to grow herbs and typical Thai ingredients
- Local meats like beef tendon, tongue, brisket

speedboatbar.co.uk

Marseille
AM by Alexandre Mazzia
- Flavors of African cuisine linked to the chef's childhood in the Congo
- 19 to 22 diners, each given a different gastronomic experience at the same time
- The importance of chili and smoke/roasting
- Combinations of chocolate and grilled fish

alexandre-mazzia.com

Barhain
FUSION BY TALA
- Chef Tala Bashmi - voted Best Chef of the Middle East
- Nostalgia and modernity combined through culinary art
- Inspiration from classic Bahraini recipes (ghoozi, bamia) in very contemporary interpretations

fusionsbytala

Inspirations



food for thought...

IS CHAOS COOKING THE NEW CUISINE?
Coming to us from the US and through social networks, this is a style of cooking that stems from a multicultural heritage (linked to mixed demographics and digital technology), freeing itself from very traditional culinary codes with a dash of "hotheadedness", in an unbounded search for complex flavors. This vision is really in line with the spirit of younger generations for whom decorum and conventional codes are taking a back seat to taste... Masala cheesesteak, Pastrami tacos...



eat future

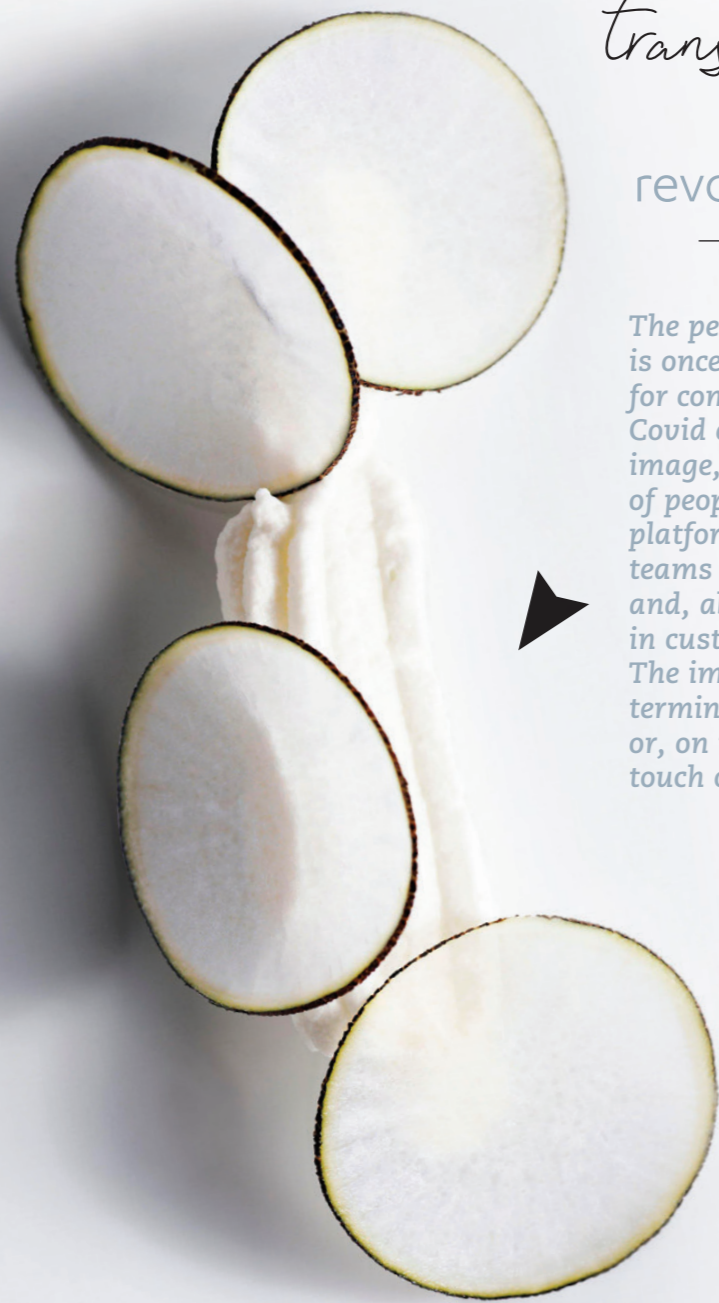

transformation
efficiency
revolution technology

The perception of technology is once again becoming positive for consumers! Covid enabled technology to improve its image, when it serves the needs of people (videoconferencing, apps, platforms, etc.). It helps Chefs and their teams prepare quality food efficiently and, above all, it is becoming essential in customer relationships. The impact of technology is not predetermined: it can remain very functional or, on the contrary, it can be fun and touch our emotions.



37%
of European consumers regularly order via an app. (NDP 2022)

40%
of US and UK consumers are "highly likely" to try lab-grown meat. (The Good Food Institute 2021)

1/2
consumers around the world would like to see more technological cooperation to create gourmet flavors, textures and/or food format combination. (Innova trends 2021)

25%
of people will spend at least one hour each day in the metaverse in 2026. (Gartner Corporation 2021)

micro-trends



1

Business models are reinventing themselves with the digital Boom in home delivery and platforms, such as virtual restaurants, collaborative cooking, training and consulting. Chefs no longer need to be in any specific physical location to exist, but the challenge is to acquire and master new digital skills!

3



Robots are being explored as a solution to labor shortages: to serve guests, notably in Japan, some robots can be controlled by people with disabilities, therefore contributing to more inclusivity. Avatar robots, with their finer sensory skills, and advances in artificial intelligence will open new potential applications to support staff and facilitate work.



2

Techno-solutions
Technology at the service of the planet and humanity: vertical urban farms to reduce inputs of resources and optimize production, laboratory meat for animal welfare, etc. New technologies are emerging to become more sustainable and create a new green way of producing food.

4



Foodverse (food metaverse) and **NFTs** (Non-Fungible Tokens)
These can be the starting points for new sensory and relational experiences. Creating recognition, rewards or discounts are things that all people desire and expect!



The Chef's interview

«Don't be afraid to delve into the unknown and make mistakes.»

François Daubinet

International Consultant Pastry Chef
• Former Compagnon du Devoir,
• Consultant since 2022
• Elle & Vire Professional Ambassador

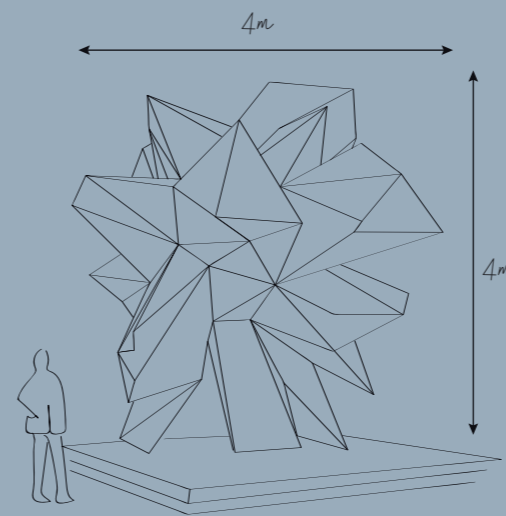

«Technology provides us with a certain type of freedom, which is a very exciting prospect for me.»

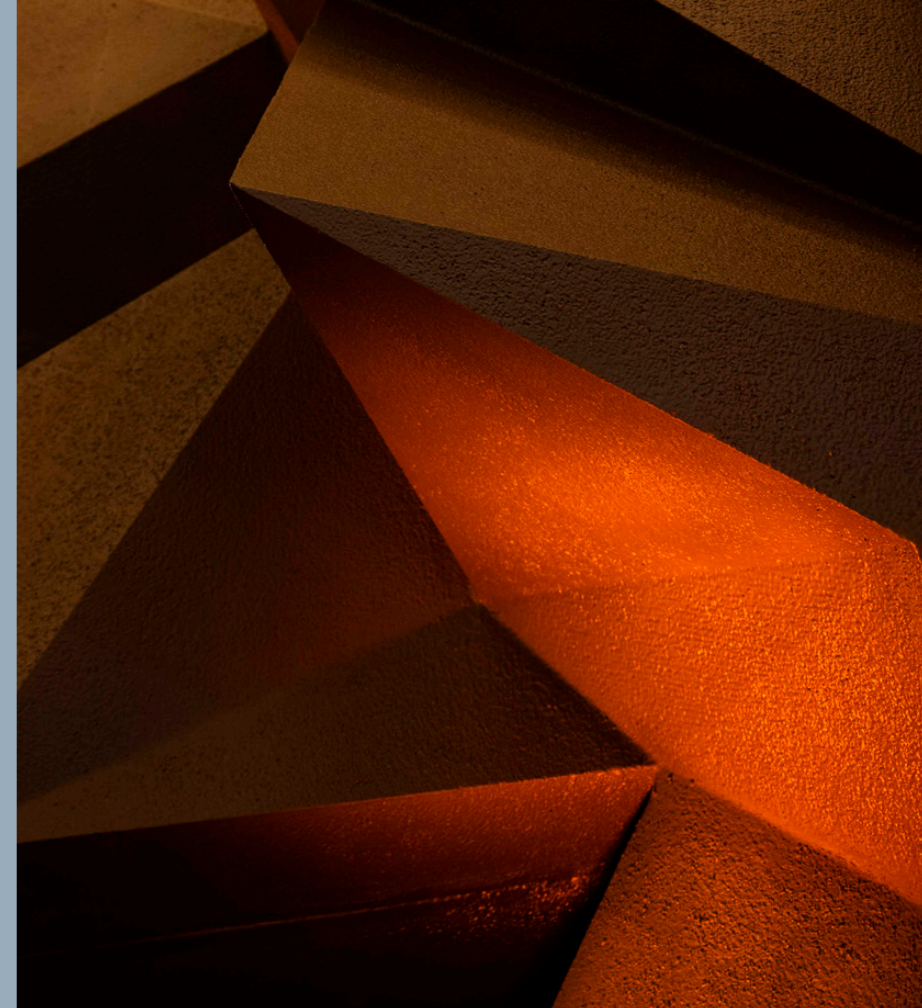

photo credit: © Geraldine Martens

How can you continue to perpetuate desire without having people taste your products?

By expressing a clear and innovative vision. Looking for inspiration in the areas that excite our passions. We are lucky today to be able to use social networks or to create videos with a smartphone, giving us incredible power to free up communication! I think that you must express your values with sincerity and intelligence, highlight the great farmers and food producers we have access to and be bold in your work.

What is your relationship with technology in pastry and chocolate making?

Once again, I think we are lucky to have access to so much technology. **You must be curious** and know how to use this technology properly. **Don't be afraid to delve into the unknown and make mistakes.** 3D printing is another revolution that is changing the world in all areas of endeavor. It's impossible for me to think that we can't harness it to innovate in gastronomy, especially in pastry making. We are now in 2023, we must live with our times and use technological innovations wisely.

What opportunities does technology offer you?

It's essential to observe other industries and other

worlds. Cold distillation, for example, is INCREDIBLE, offering enormous creative opportunities. Innovation allows us to free ourselves from constraints. **Technology provides us with a certain type of freedom, which is a very exciting prospect for me.**

What do you think of new assistance tools and their impact on your daily work?

I think that these technological advances must be used intelligently (...). We are facing a shortage of manpower in our craft trades; these new assistance tools are already and will increasingly be one of the many solutions for the future to guarantee the quality of products and to recruit and keep personnel.

Evolution is natural, while opposing it is a waste of time and energy.

Which technologies do you think are the most interesting to explore?

I recently saw service robots in Singapore, which assist the serving staff to carry plates and trays. It's fantastic! I think that technology is useful for dealing with all the repetitive tasks that need to be done endlessly. Technology is a very good thing if it frees up people to enable them to focus on high value-added tasks. I prefer to look forward rather than backwards.

What is the impact of home delivery on desserts and pastries?

I think that pastry is certainly the least developed sector in home delivery, for one obvious reason, which is the fragility of desserts! For cookies, verrines and chocolate it's perfect, for the rest it's less obvious. You must respect the cold chain, create specially adapted desserts and design appropriate packaging. However, we have a clean sheet **we must work on**, so we don't miss the boat and stay on the shore as the future drifts away. In my opinion, Claire Heitzler is a pioneer who is at the forefront of what we need to do.

What opportunities do you see for the pastry/chocolate industry in the future, on Web 3.0?

As is the case for the rest of my work, I am very curious to see what we will be able to achieve soon, especially in augmented reality and through immersive experiences. **The biggest challenge is to transpose a taste emotion through the other senses of smell, hearing, sight, and touch.** It's exciting to imagine an experience like this and I'm looking forward to being among the first to participate in this adventure as a contributor or creator.

What are your latest projects?

The Maison de l'Excellence Savencia, Elle & Vire Professional and Valrhona helped and supported me in the creation of an ephemeral work for the Salon du Chocolat at the end of 2022.

I was able to create a chocolate crystalline sculpture, 4 meters high and 4 meters in circumference, which represents **my interpretation of the cocoa butter crystallization process.** This polystyrene structure was **made using AMC 44's digital machining** and painted with 200kg of **recycled chocolate**, initially destined for disposal. The next step will be to sell works like this to raise funds and donate them to charities and non-profit organizations that work every day to help people in difficult situations, either because they have disabilities or are simply in need.

What are your upcoming projects?

I have just published my first book INSPIRATIONS, published by La Martinière. This book talks about the beauty of the creative process through 10 stories of collaboration between different arts and crafts. This is exactly what I want to do with my career in the future, exploring creation and art more deeply!

"Eggceptional"

by Yannick Tranchant

Chef and owner of the restaurant L'Escargot 1903 (Puteaux)
Ambassador of Elle & Vire Professional

Cooked at 63° in a steam oven is the best technique for bringing out the true taste of a free-range egg, combined with the use of a dehydrator to create lace-like tiles with fine spinach powder. We suggest topping off this dish with a cream of parmesan and preserved lemons, fresh chickpeas, and fried shallots.



scan for the recipe

Ingredients & flavors

57% of Australian people intend to use a food delivery service at least once a week (NPD)

Takeaway desserts are becoming increasingly sophisticated: in jars, for example, or with ingredients made available in parts, with a tutorial for home preparation. Recipes must be adapted to each purpose (textures, decorations, etc.) and packaging must also be designed to limit risks and waste.



415,2 million interactions with #TikTokFood (Visibrain)

Is TikTok the new food trend agency?

TikTok is the medium for millions of conversations about food every day. Butter boards create a sense of familiarity, combined with a sense of accessible novelty. Chefs recommend using high quality, salted butter to get the best flavors, using a bread 'board' rather than wood...

3rd most consumed drink in the world - coffee

Reinventing capsule-free coffee

The Swiss "coffee ball" (Coffee B) is a small sphere made of compressed coffee, without packaging. It is simply coated with a very thin 100% vegetable-based envelope to guarantee its stability and protect its aromas. It is made without plastic or aluminum and can be composted at home after use.



the technique

ADDITIVE MANUFACTURING OR 3D PRINTING

75% of consumers would be motivated by the novelty of trying or eating 3D printed food products (Campden BRI study 2019)

Pastry and chocolate makers were the first to use this technology in the food industry to personalize decorations and molds.

In addition to the shape of the product, additive manufacturing enables customization of the texture and composition of food, as well as the possibility of composing recipes and reprocessing by-products.

the vision

la maison de l'Excellence®



Technology is a permanent fixture in a kitchen or pastry shop. It provides essential working comfort, especially for the upcoming generations. It opens new opportunities for textures, flavors, cooking choices. It allows us to gain in accuracy. **It must be used to promote wellness and contribute to a better planet and the well-being of Chefs and their teams.** The problem isn't technology but what we do with it.



“ **Work on your takeaway offer by reducing your carbon footprint with (truly) recyclable containers, well-adapted portions of recipes that guarantee a quality experience for people at home. As an added advantage, bring people back to the restaurant by offering faster service or an unforgettable experience...** ”

inspiring places



Los Angeles

- AMAURY GUICHON
- 42 million followers on social networks
- Most of his audience has never tasted his creations
- Makes his own chocolate sculptures or illusionist pastry videos
- Influencer business model who also gives classes in his academy and offers products in his online shop



thepastryacademy.com

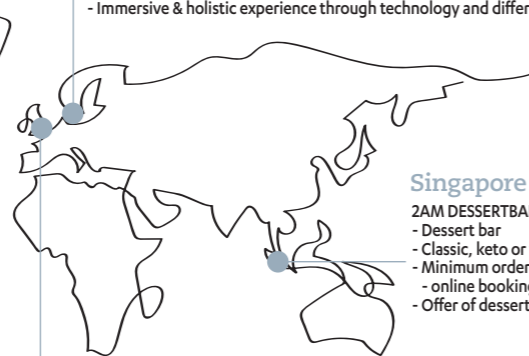

Copenhagen

- ALCHEMIST
- Chef Rasmus Munk
- Conceptual and disruptive dishes
- With strong social messages (anti-plastic pollution)
- Seeking to have an impact on society
- Immersive & holistic experience through technology and different arts.



alchemist.dk

Singapore

- 2AM DESSERTBAR
- Dessert bar
- Classic, keto or vegan recipes
- Minimum order of \$20 per guest on site
- online booking and Grabfood pick-up service
- Offer of desserts in jars and snacking packages



2amdessertbar.com

London

- ROSEWOOD ART AFTERNOON TEAS
- Experiential art afternoon tea
- Executive Pastry Chef: Mark Perkins
- Use of augmented reality during tasting
- NFTeas collection



rosewoodhotels.com/en/london/dining/art-afternoon-tea

Inspirations



food for thought...

IS IT NECESSARY TO HAVE YOUR BRAND IN THE METAVERSE TO PROTECT IT?

The future of Web 3.0 is still unclear. However, is it necessary to be present and assert yourself in this space, as well as to improve your learning skills? The "meta-Birkin" dispute illustrates the intellectual property issues related to NFTs and the metaverse. This may still be the wild west in this gold rush, but is there real fortune to be found?





Excellence dedicated to Professionals

OUR COMMITMENTS

ADAPTATING OUR OFFER TO ALL PROFESSIONALS

We develop and market products for French and international catering and bakery-pastry professionals.

A CLOSE WORKING RELATIONSHIP

We collaborate with many professionals who contribute their expertise to develop products and services in line with their expectations and needs, from initial design to the final product.

CONSTANTLY FOSTERING NEW WAYS OF THINKING TO CREATE NOVELTY

Our teams are constantly on the lookout for new concepts and new trends. Thanks to our know-how and market expertise, we develop technical products that are faultless, consistent and adapted to the uses of each professional.

DEDICATED SERVICES TO SUPPORT PROFESSIONALS

With the help of our pastry and culinary experts, we develop tools and services to support you daily. Our Chefs create seasonal recipes and welcome you to La Maison de l'Excellence Savencia® for training sessions.



Find more about our brands Elle & Vire Professionnel, Corman and Lescure on our websites and social networks



La Maison de l'Excellence®



La Maison de l'Excellence Savencia® passes on its expertise and its values of listening and sharing throughout the world.

Located in the Parisian suburb of Viroflay, La Maison de l'Excellence Savencia® is a place for sharing and passing on expertise to French and international catering and bakery-pastry professionals, as well as a place for reflecting on the culinary and patisserie trends of tomorrow. Nicolas Boussin, pastry chef and winner of the Best Craftsman in France for Pastry in 2000, and Michelin-starred chef Sébastien Faré welcome chefs all year round at La Maison de l'Excellence Savencia® for individual or group training sessions. A team of chefs in the field supports professionals throughout the world.

OUR MISSIONS



INSPIRE

Professionals through collections of recipes and trend books.



PROVIDE

Professionals with technical advice and techniques



THINK

About future innovations in collaboration with professionals.



SHARE

Their product knowledge and expertise



THE CHEF'S MAGAZINE 2023

La maison de l'Excellence®



02